

# Data Sheet



Article number: 20165369

Description: E+G Cabinet U-handle GN 426-AL-20-350-BL

## Measures

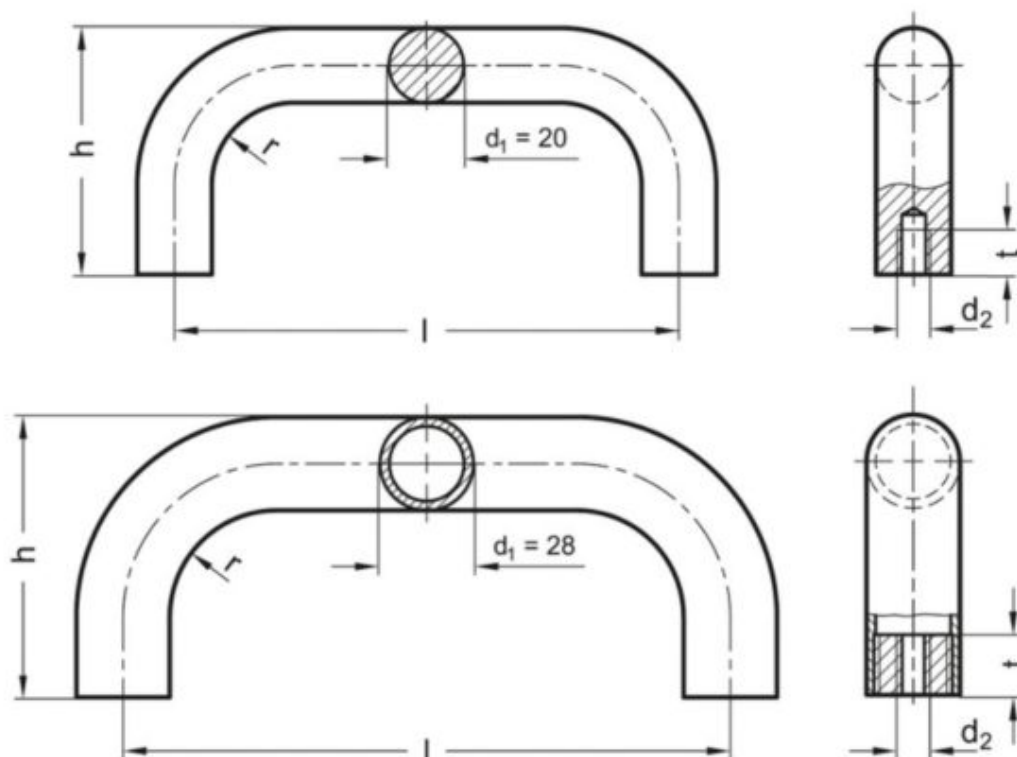

$d_1$	= 20
$d_2$	= M8
$h$	= 68
$l$	= 350
$r$	= 22
$t_{min}$	= 15